

1 of 6

SHAPE UP ALL PILLOWS AND CUSHIONS!

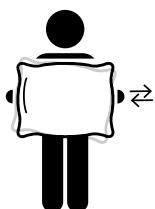

1: A1 + C

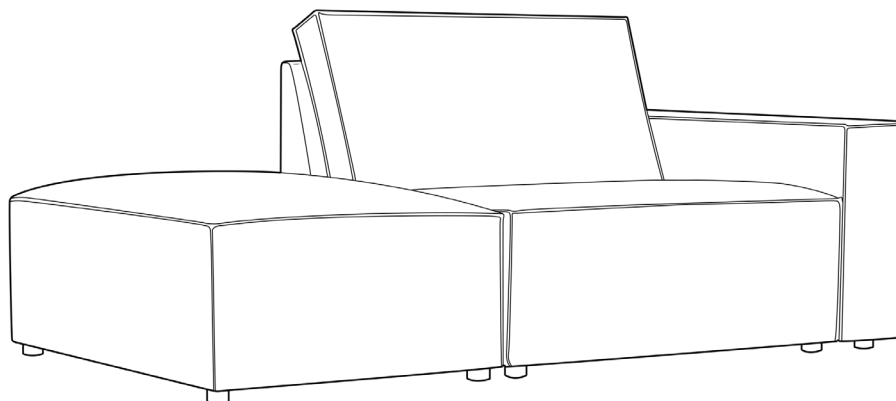
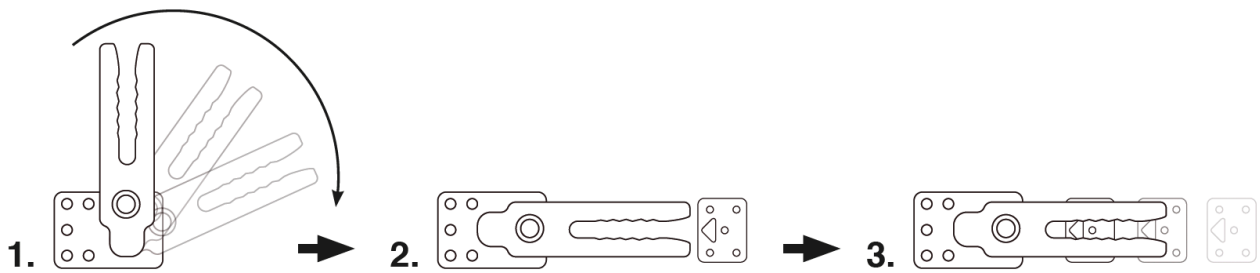
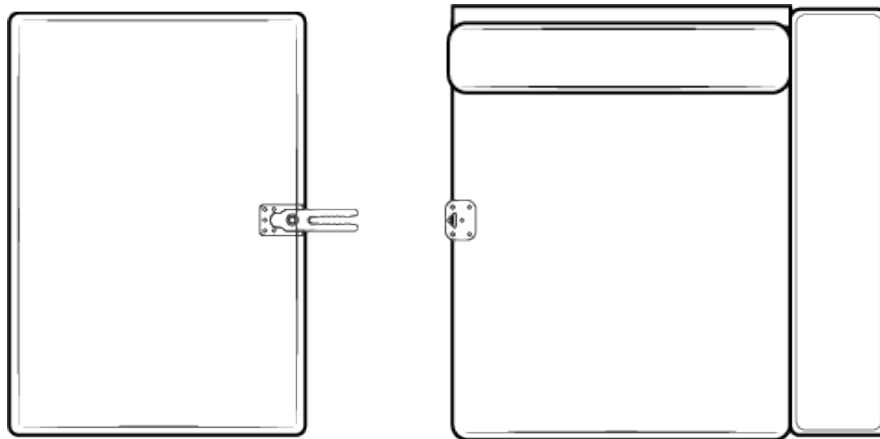
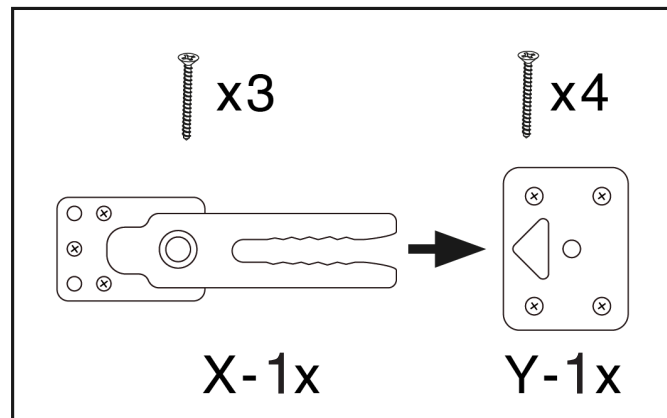

2: A1 + A2

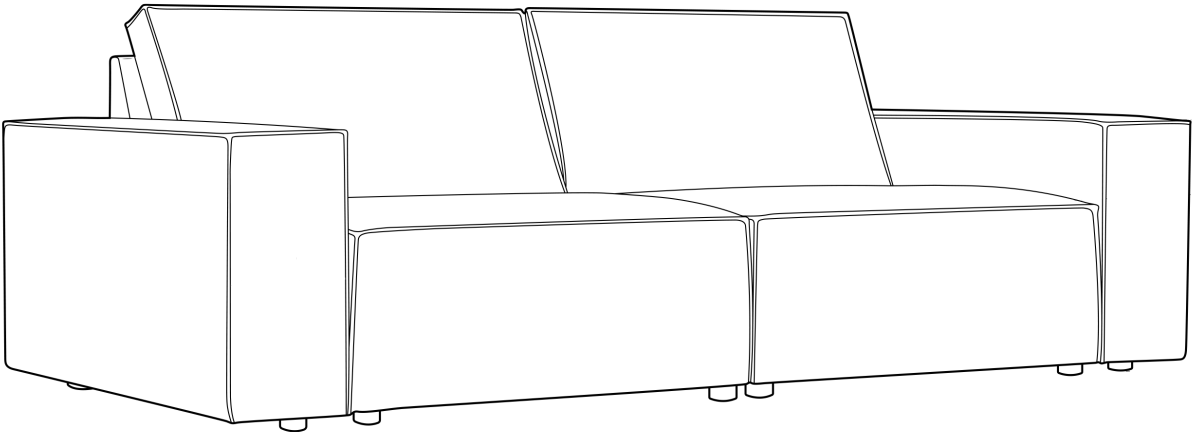
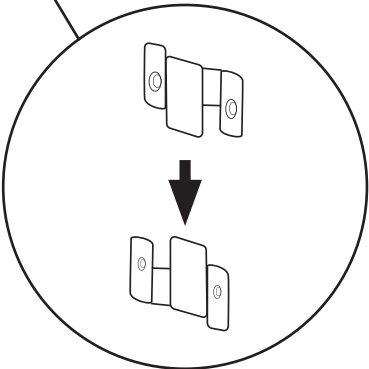
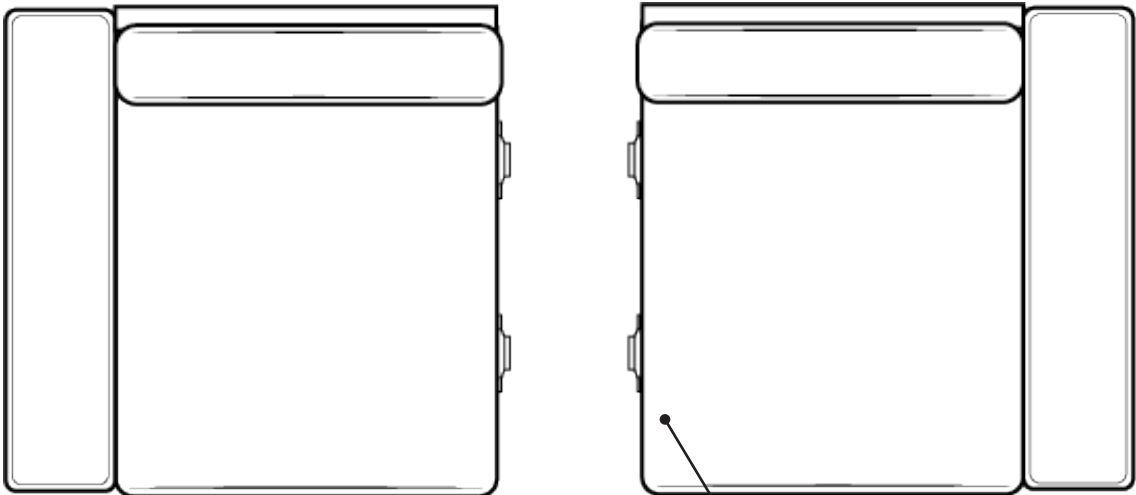

3: 2x B + C + G

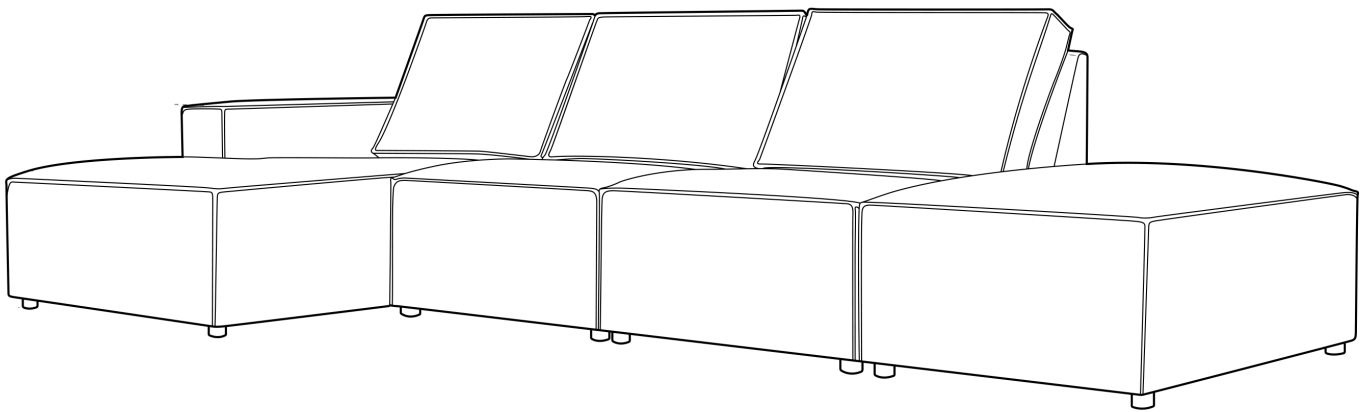
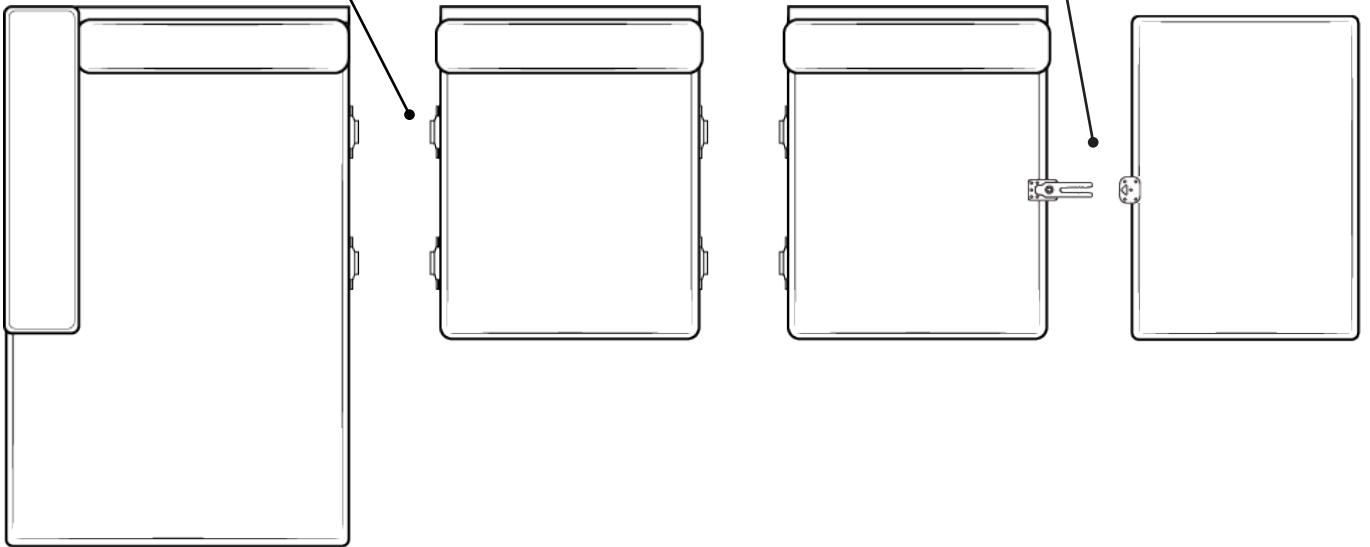
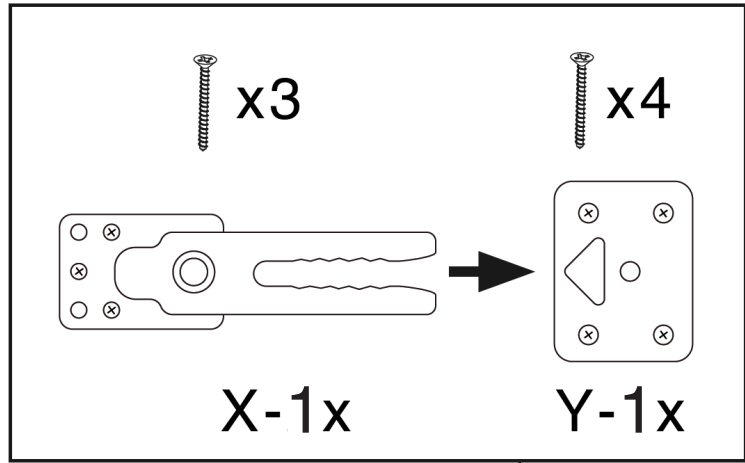
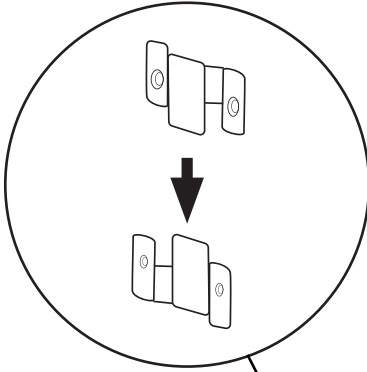

4: 3x B + C + D + G

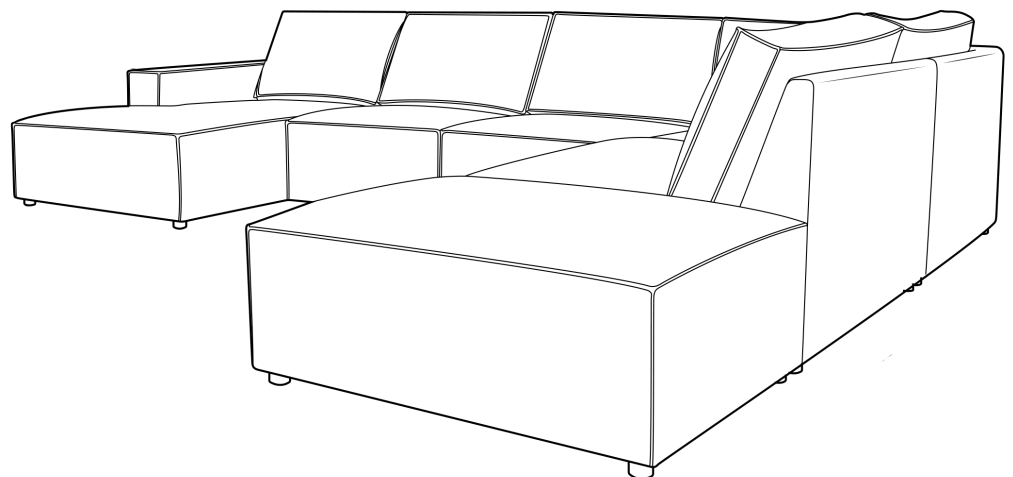
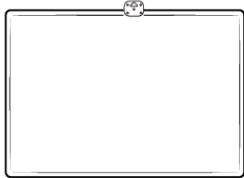
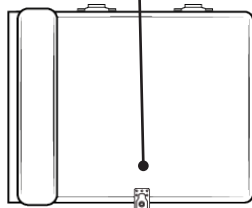
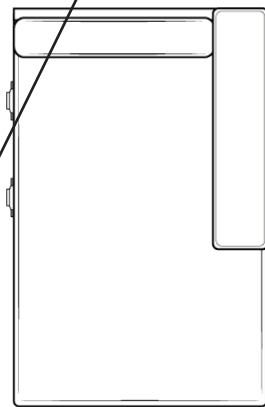
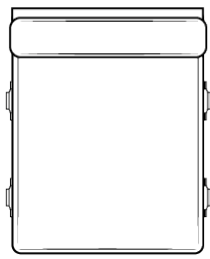
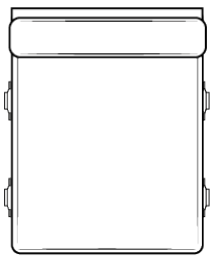
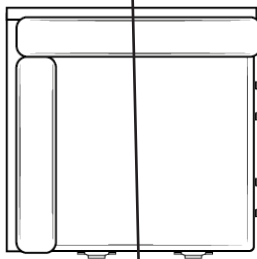
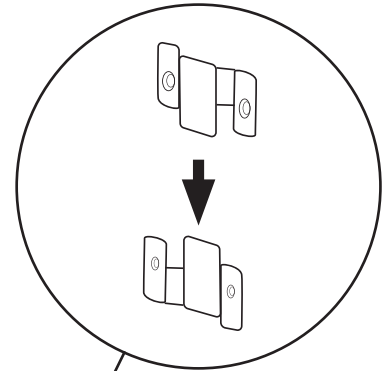
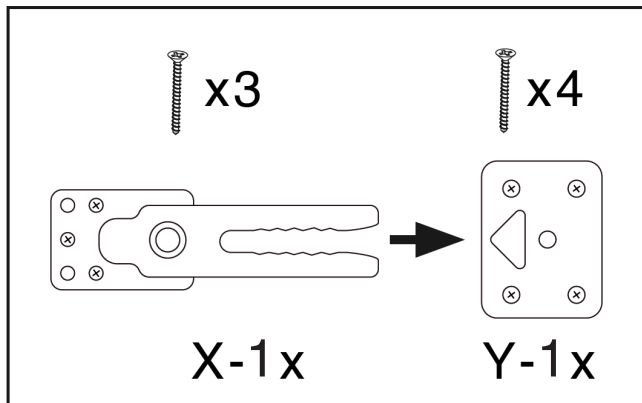

5: 2x B + D + E + F

