

NOTICE DE MONTAGE
 ASSEMBLING INSTRUCTIONS
 ISTRUZIONI DI MONTAGGIO
 MONTAGEANTEILUNG
 ISTRUÇÕES DE MONTAGEM
 MANUAL DE MONTAJE
 SASTAVLJANJE UPUTE



AVANTI DI COMMINCIARE
 RIPORTATE AGLI CONSIGLI DI
 MONTAGGIO

VOR DIE MONTAGE, BITTE
 BEILIEGENDE ANWEISUNGEN
 FOLGEN

PRIJE POČETKA OBRATITE
 U okupljanje savjet u DODATKU

AVANT DE COMMENCER, SE
 REPORTER AUX CONSEILS
 DE MONTAGE EN ANNEXE

BEFORE STARTING REFER
 TO THE ASSEMBLING ADVICE
 IN ANNEX

ANTES DE COMERCAR, ADIARSE
 AOS CONSELHOS DE
 MONTAGEM EM ANEXO

ANTES DE EMPEZAR
 CONSULTE LOS CONSEJOS
 PARA EL MONTAJE

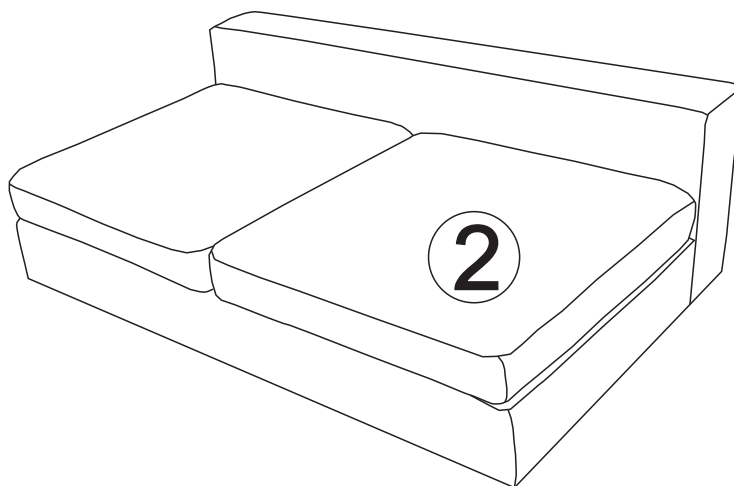
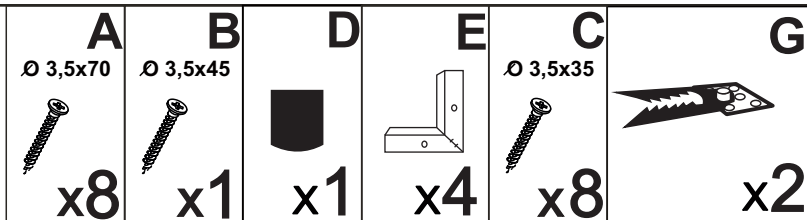

NOTICE DE MONTAGE
 ASSEMBLING INSTRUCTIONS
 ISTRUZIONI DI MONTAGGIO
 MONTAGEANTEILUNG
 ISTRUÇÕES DE MONTAGEM
 MANUAL DE MONTAJE
 SASTAVLJANJE UPUTE
 INSTRUKCJA MONTAŻU

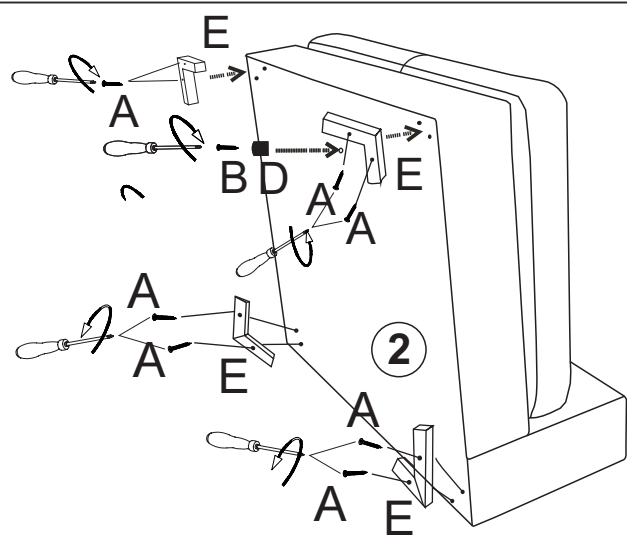
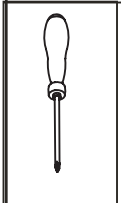
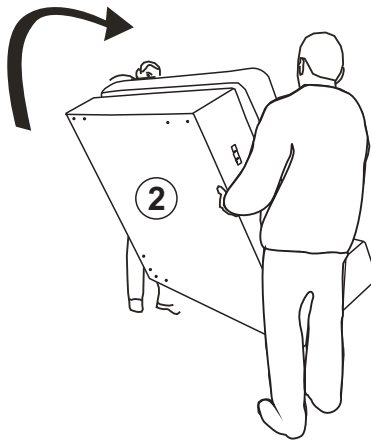

A Ø 3,5x70 x8	B Ø 3,5x45 x1	D x1	E x4
--------------------------------	--------------------------------	--------------------	--------------------

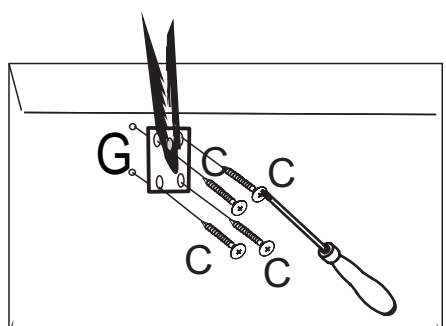
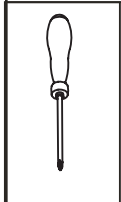

C Ø 3,5x35 x8	G x2
--------------------------------	--------------------

OPTION I

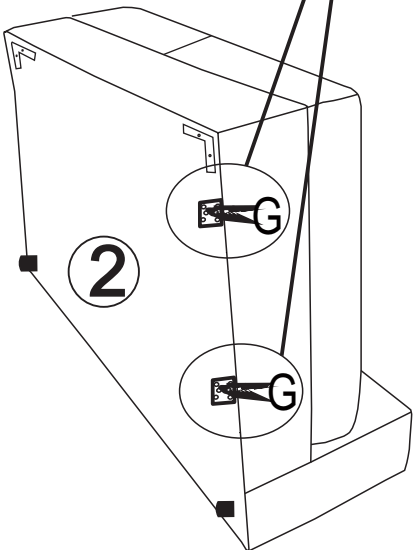

OPTION II

